

## Description

The system is intended as a safety device for the control of doors & gates. It comprises a static unit (connected to the control unit) and a maximum of 4 mobile units per relay, which are able to function both with clean contacts or 8K2Ω safety edge. Relative to the safety edge (either clean contact or 8K2Ω), the contacts of static unit relays 1 & 2 (Normally Closed with the powered device) can either be connected to the relevant input of the control unit, placed in series with the gate control panel's stop circuit or wired in series with a photocell. The transmission of the signal is at 868Mhz

**WARNING!** The installation and maintenance of the system **MUST** be carried out by qualified personnel.

This device can lock door/gate automation if the mobile unit's battery is flat. As it is necessary to open the transmitter in order to change the battery, this must be done by qualified personnel ONLY.

## Configuration & Electrical Connections

### Mobile Unit:

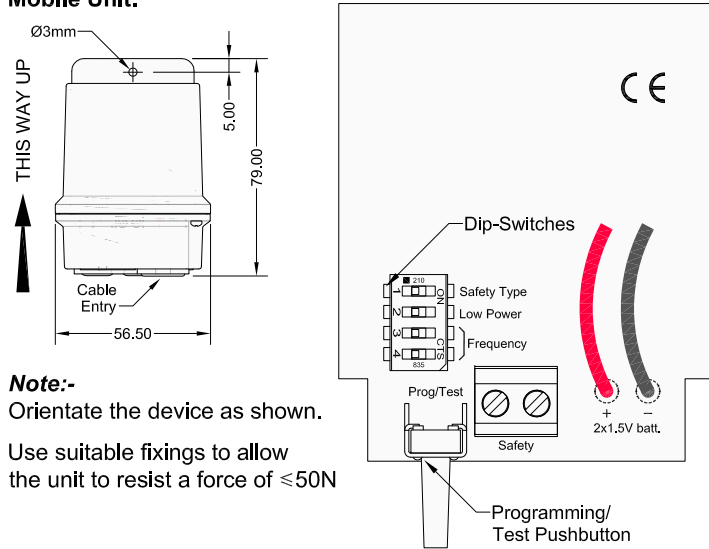

### Note:-

Orientate the device as shown.

Use suitable fixings to allow the unit to resist a force of  $\leq 50N$

### Dip-Switch Settings

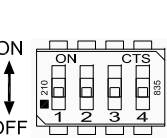

Dip Sw.	Function	Status			
1	Reserved	Not Used		Not Used	
2	Energy Saving	ON - Test every 15 seconds		OFF - Test every 1 second	
3	Frequency Setting	ON - Freq. 1	ON - Freq. 2	OFF - Freq. 3	OFF - Freq. 4
4		ON - Freq. 1	OFF - Freq. 2	ON - Freq. 3	OFF - Freq. 4

**Note:-** A maximum of 4 transmission channels may be associated to each static unit relay.

**WARNING!** To ensure that the system functions correctly, the frequency of all mobile units must be set identically to their corresponding static unit, via Dip-Switches 3 & 4.

### Programming

Learning of mobile devices to Static Unit **Relay No.1**

- Ensure that the settings of Dip-Switches 3 & 4 on both the static and mobile units correspond.
- Press & release the Test button on the static unit. A single beep is emitted.
- Press & release the Programming/Reset button on the mobile unit. The static unit will emit two beeps.
- The Learning operation is complete.

To programme more mobile devices, repeat operational steps 1-4

### Static Unit:

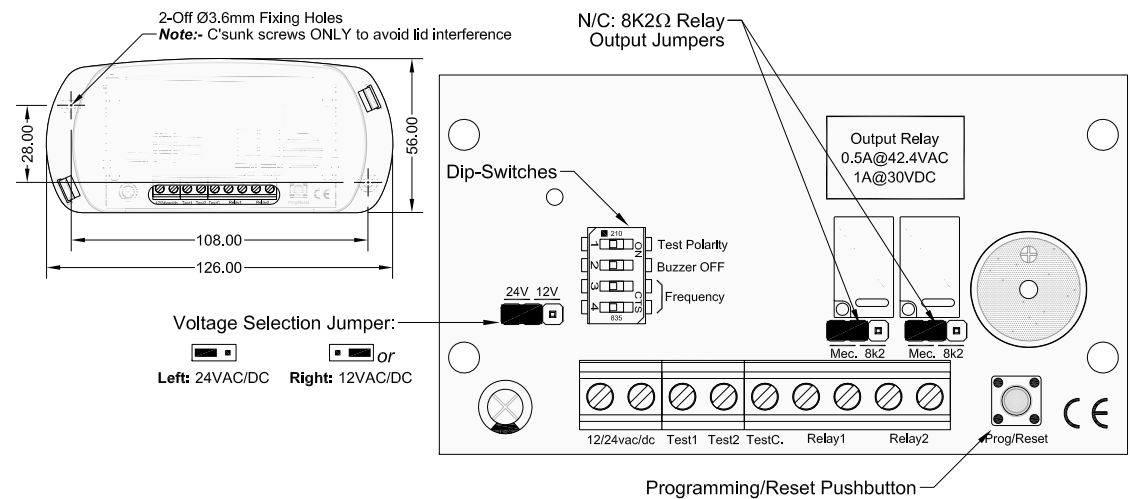

**WARNING!** The output signal of Relays 1 & 2 (i.e. either a clean contact or 8K2Ω safety edge) depends on the position of the Selection Output Signal jumper.

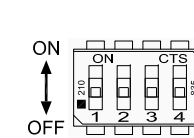

Dip Sw.	Function	Status			
1	Test Input	ON - N/C Contact		OFF - N/O Contact	
2	Buzzer ON/OFF	ON - Static Unit's Buzzer ON		OFF - Static Unit's Buzzer OFF	
3	Frequency Setting	ON - Freq. 1	ON - Freq. 2	OFF - Freq. 3	OFF - Freq. 4
4		ON - Freq. 1	OFF - Freq. 2	ON - Freq. 3	OFF - Freq. 4

### Programming

Learning of mobile devices to Static Unit **Relay No.2**

- Ensure that the settings of Dip-Switches 3 & 4 on both the static and mobile units correspond.
- Press & hold the Programming/Test button on the static unit until two beeps are emitted.
- Release the Programming/Test button on the static unit.
- Press & release the Programming/Reset button on the mobile unit. The static unit will emit two beeps.
- The Learning operation is complete.

To programme more mobile devices, repeat operational steps 1-5

T: +44 (0)1928 579050

F: +44 (0)1928 579259

www.linkcontrols.co.uk

sales@linkcontrols.co.uk

Link Controls

Marantec

Stuart Rd, Manor Park, Runcorn, Cheshire, WA7 1TS

Title:-

TRANSCIVER SYSTEM FOR RESISTIVE AND NORMALLY CLOSED SAFETY EDGES  
STOCK CODES: AE0-930 (R.CO.O) & AE0-931 (T.CO.O)

Drawing No:- LC-2898

Page No:- 1 of 2

Revision No:- D

Rev Date:- 15/07/15

Drawn By:- C.J.W.

Date:- 18/05/09

Checked By:- A.M.

Appr' By:- S.L.

## Typical Wiring Examples

**CS-310 (Mechanical/Pneumatic Safety Edge)**

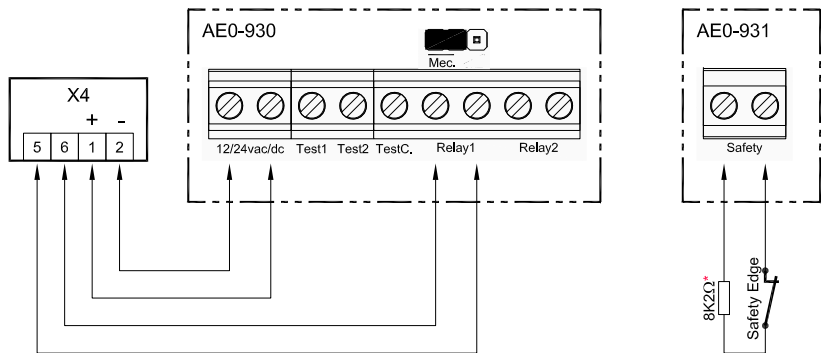

**CS-310 (Conductive 8K2Ω Safety Edge)**

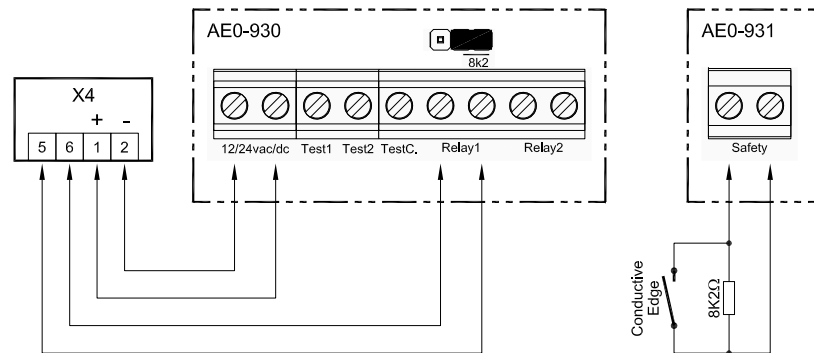

**CS-250 (Mechanical/Pneumatic Safety Edge)**

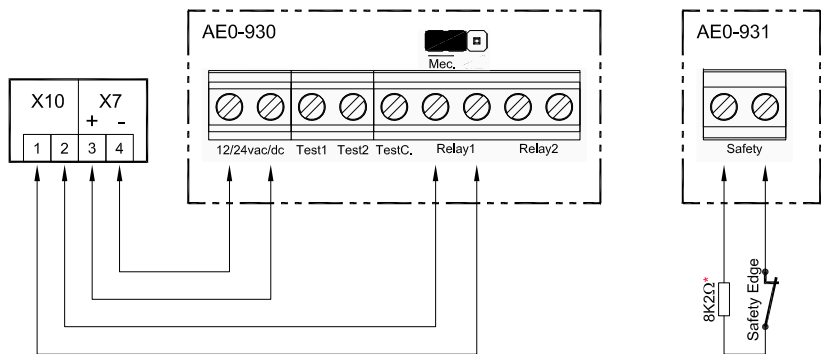

**VST-150 (Conductive 8K2Ω Safety Edge)**

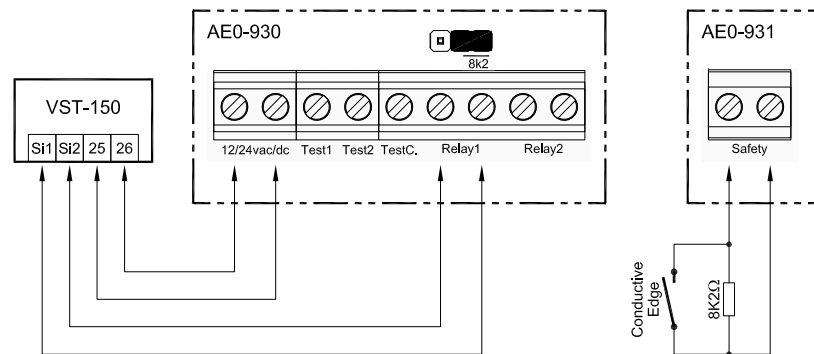

**\*Reference:** It is essential that an 8K2Ω resistor is connected in series when using a N/C contact. If the safety edge has it's own resistor, Do Not fit resistor.

**Note:-**  
The control unit connected to the device must be able to handle an 8K2 Ω signal if this option is used. Ensure that unit is sited in an area that is able to provide suitable access. Ensure that the unit is kept free from dust and excessive vibration. The acoustic noise level of the unit is less than 70dBA.

**WARNING!** If the receiver's power supply is an AC supply, the power supply **MUST** go via an isolating transformer (SELV Voltage), which will have limited power or short circuit protection.

**DISCLAIMER:** Link Controls Ltd. cannot be considered responsible for damage caused by improper or incorrect use of the product.

### Fault Finding

No. of Beeps	Explanation	Solution
1	Regular functioning, system healthy	No action required
2	One or more safety edges on alarm or activated	Check that the safety edge is connected
3	One or more safety edges disconnected	Check that the safety edge is connected
4	Battery voltage low	Replace the battery of the indicated device
5	Battery voltage very low	Replace the battery of the indicated device
6	One or more associated devices disconnected	Check each associated device (Learning)

T: +44 (0)1928 579050  
F: +44 (0)1928 579259  
www.linkcontrols.co.uk  
sales@linkcontrols.co.uk

**Link Controls**  
**Marantec**

Title:-

TRANSCIVER SYSTEM FOR RESISTIVE AND NORMALLY CLOSED SAFETY EDGES  
STOCK CODES: AE0-930 (R.CO.O) & AE0-931 (T.CO.O)

Stuart Rd, Manor Park, Runcorn, Cheshire, WA7 1TS

Drawing No:- LC-2898	Page No:- 2 of 2
Revision No:- D	Rev Date:- 15/07/15
Drawn By:- C.J.W.	Date:- 18/05/09
Checked By:- A.M.	Appr' By:- S.L.